

HT41899P

Quick Start Guide

Schnellanleitung
Guide de démarrage rapide
Guía Rápida all'uso
Guía de inicio rápido
クイックスタートガイド



Video Guide,
User Manual, FAQs



Product Overview

Produktübersicht | Aperçu du produit | Panoramica del prodotto | Descripción general del producto | 製品概要

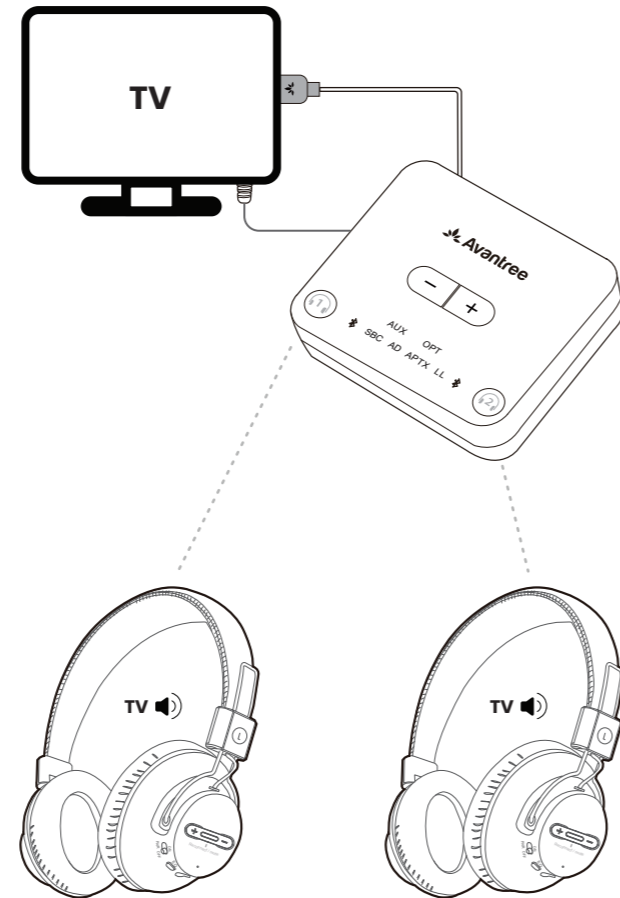

Setup

Einrichtung | Configuration | Configurazione | Configuración | セットアップ

1 Connect Transmitter to TV & Power

Anschließen des Senders an Ihren Fernseher | Connexion de l'émetteur à votre téléviseur | Collegamento del trasmettitore al tuo TV | Conexión del transmisor a su televisor | 送信機をテレビに接続する

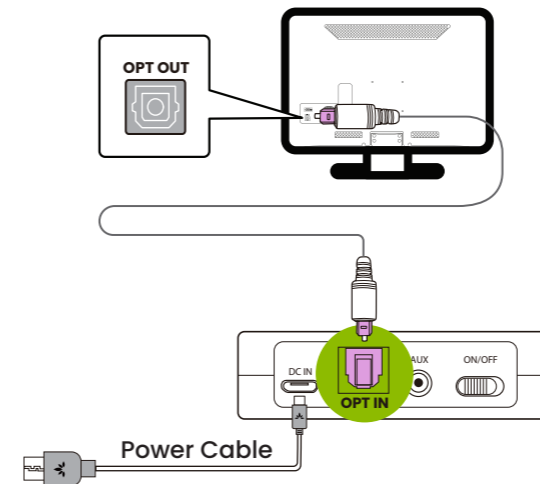

AUX Connections



2 Change TV Audio Settings

TV-Audioeinstellungen ändern | Modifier les paramètres audio de la TV | Modificare le impostazioni audio della TV | Cambiar la configuración de audio del televisor | テレビのオーディオ設定を変更

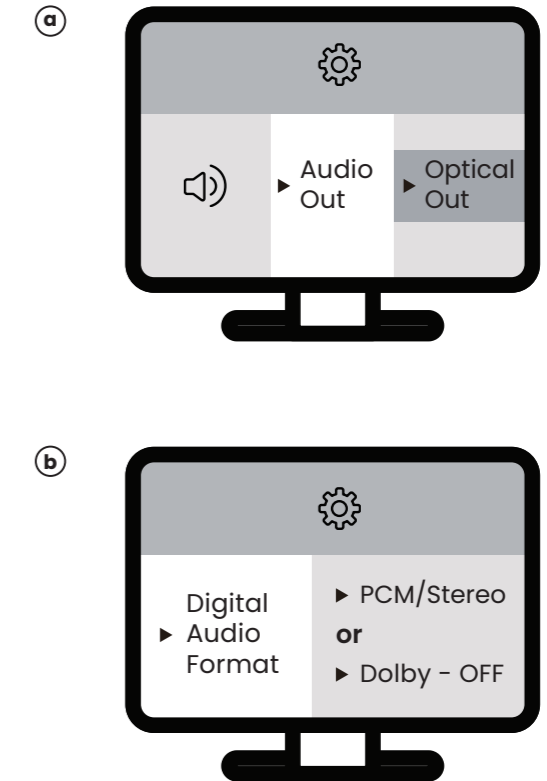

3 Turn On the Headphones and Transmitter

Kopfhörer und Sender einschalten | Allumer les écouteurs et l'émetteur | Accendi le cuffie e il trasmettitore | Encender los auriculares y el transmisor | ヘッドフォンと送信機をオンにする

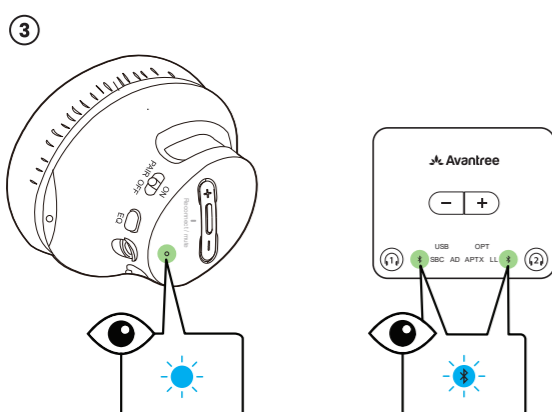
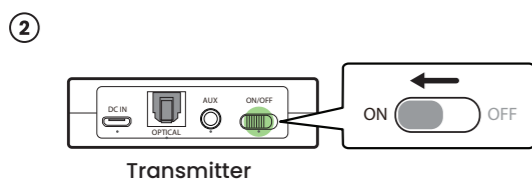
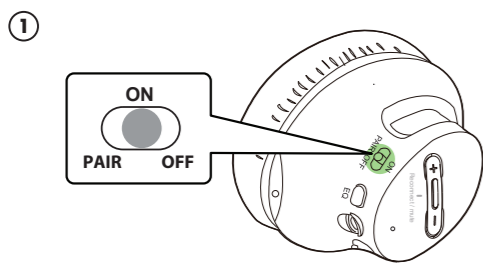

Volume/EQ Adjustment

Lautstärke/EQ-Anpassung | Réglage du volume/égali seur | Regolazione del volume/EQ | Ajuste de volumen/EQ | 音量/EQ調整

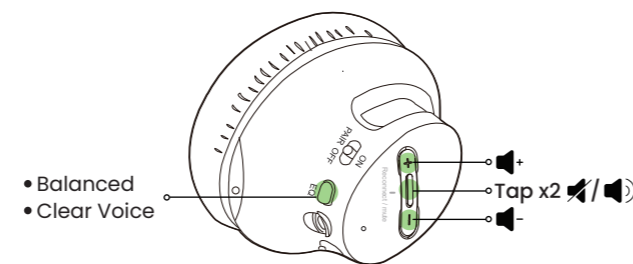

Charging

Aufladen | Charge | Ricarica | Cargat | 充電

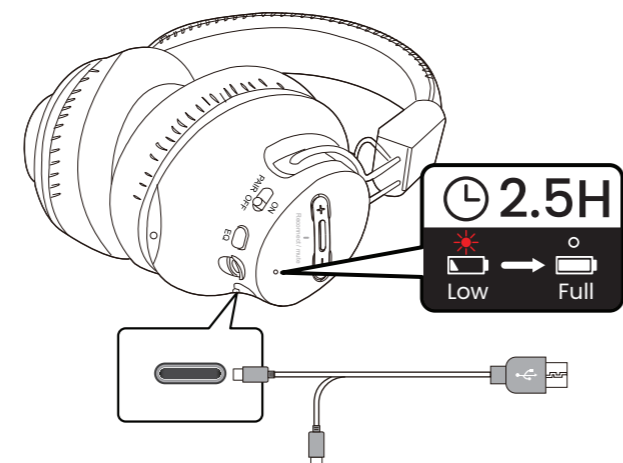

Contact Us

Kontaktieren Sie uns | Contactez-nous | Contattaci | Contáctenos | お問い合わせ

avantree.com/submit-a-ticket

support@avantree.com

US	+1 800 232 2078	9am-5pm PST	Mon-Fri
CA	+1 800 232 2078	9am-5pm PST	Mon-Fri
UK	+44 208 068 2023	9am-6pm GMT	Mon-Fri
DE	+49 322 2109 7297	10am-5pm CET	Mon-Fri
FR	+33 17 634 0312	10am-5pm CET	Mon-Fri
IT	+39 069 4803 330	10am-5pm CET	Mon-Fri
ES	+34 93 1786 261	10am-5pm CET	Mon-Fri
AU	+61 2 8310 9897	11am-7pm AEST	Mon-Fri

avantree.com/support/41899p

Scan QR code on the product to register for 24-month warranty.

詳細な説明書が必要な場合は、以下のリンクからダウンロードしてください avantree.com/41899p/manual-jp

EC REP

EU Importer and Responsible Person:

Avantree Europe Z O.O.
Ul. Żołnierzy i Dywizji Wojska
Polskiego 78a/2 84-230 Rumia,
Pomorskie, Poland
+48 22 307 25 37
support-eu@avantree.com

US Importer:

Avantree Corporation
San Jose, California 95119 USA
+1 800 232 2078
support@avantree.com

Manufacturer:

Avantronics Limited
Luohu District, Shenzhen
518000 China
+86 755 8228 5022
support@avantronics.com

UK Importer:

Avantree Limited
Watford, WD180 0HQ UK
+44 20 8068 2023
support-uk@avantree.com

Battery Manufacturer and Responsible Person:

Shenzhen Keruilong Technology Co., Ltd.
Building 3-2, Fudigang Second Industrial Zone,
Pingdong, Pingdi Street, Longgang, Shenzhen, China
+86 137 1380 2030
3354641970@qq.com



Item No.: BTH-41899-P
Model No.: BTTC-418-P-BLK; BTHS-AS95
FCC ID: WJ5-BTHS-AS95; 2A1TF-BTTC-418-P
IC: 8475A-BTTC418; 8475A-AS95
Made in China

Z-PKQ-41899-BLK-V12