

User Manual

Wireless Headphone System

WSHT-380

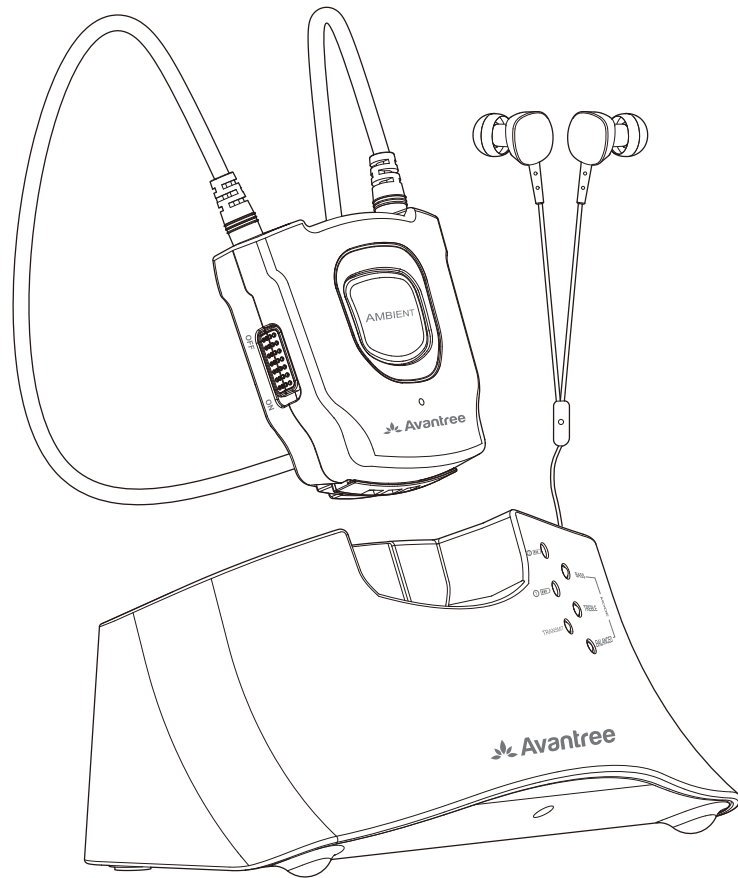

Overview.....	1
LED indication & voice prompts.....	2
Setting up the HT380.....	2
Connecting the Transmitter to your TV/audio source.....	3
Check your TV/Audio Source output options.....	3
TVs with DIGITAL OPTICAL/SPDIF Audio Out	4
TVs with AUX 3.5mm Audio Out	5
TVs with RCA audio out (Red/White ports labeled "AUDIO OUT").....	5
Receiver with 6.35mm Phone Jack at Front	6
If you cannot reach/do not have output ports on your TV.....	7
Ambient function.....	7
Left-Right audio balance control	8
Mode selection	8
Charging	8

Overview

Transmitter / Charging Dock

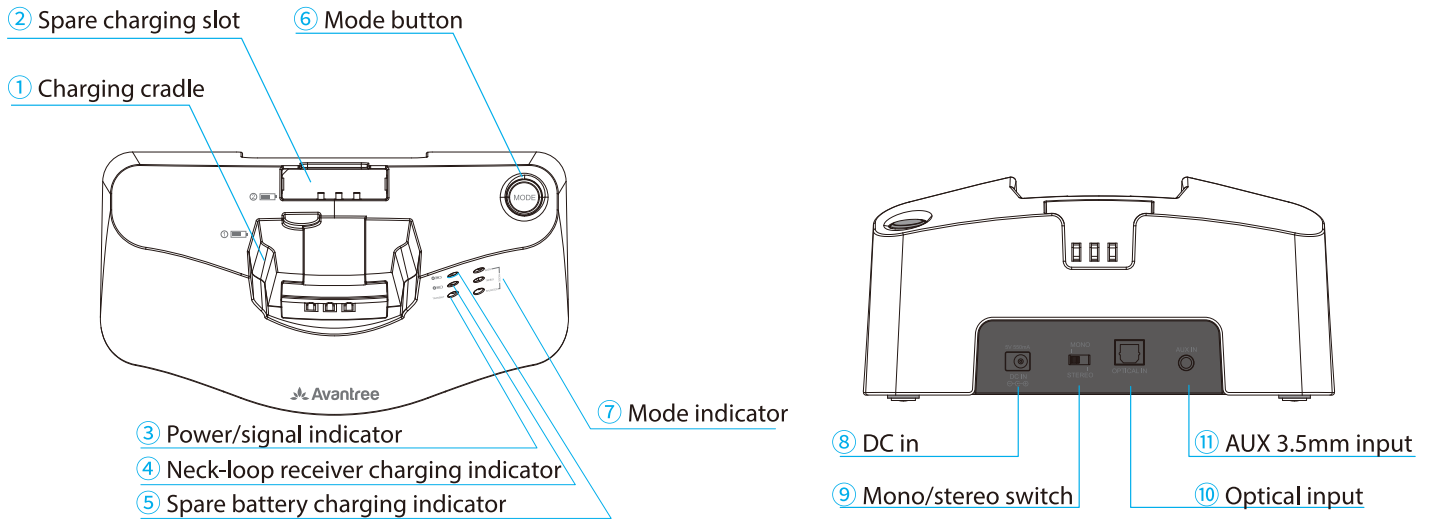



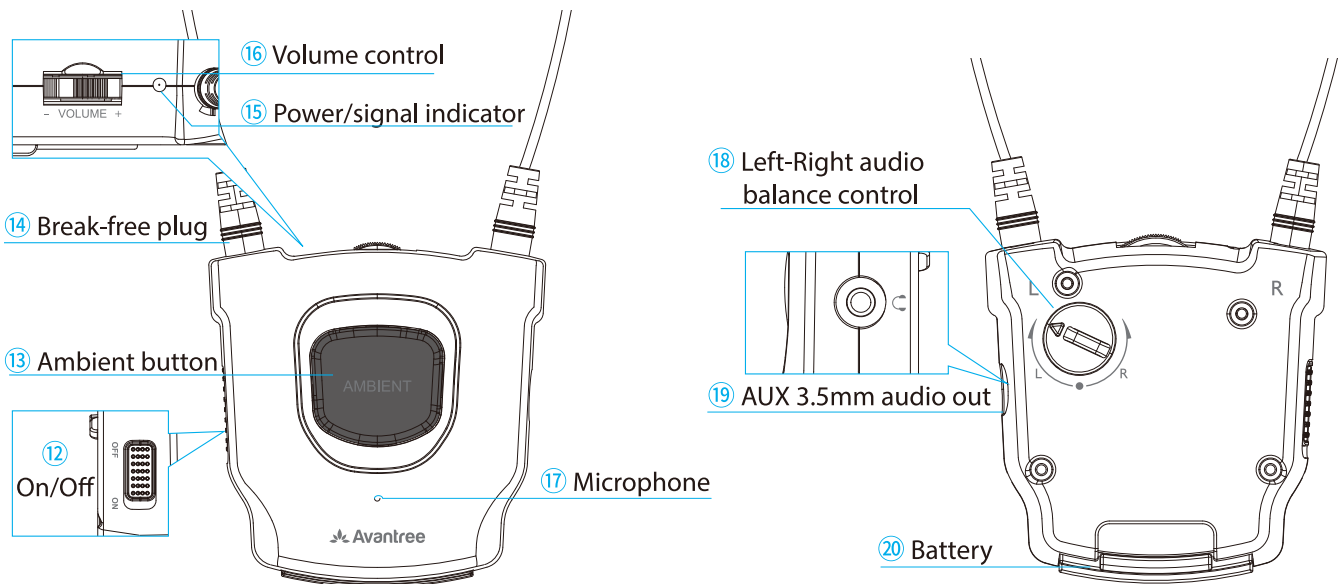





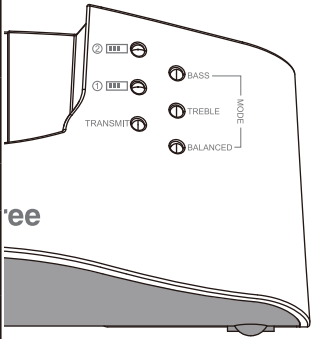

Neck-loop Receiver



LED Indication & Voice Prompts

LED Indication

	LED Indicator	Status	
 <p>Transmitter/Charging Dock</p>	③ TRANSMIT 	Lights up Green	Power on
		Solid Green	If audio signal detected (1 minute after power on)
		Flash Green	If no audio signal detected
	④ ①  	Solid Red	Charge the neck-loop receiver
		Solid Green	Fully charged
	⑤ ②  	Solid Red	Charge the spare battery
		Solid Green	Fully charged
⑦    		LED indicator lights up accordingly when the corresponding sound mode is selected.	

 <p>Neck-loop Receiver</p>	⑮ 	Solid Green	Connected with the transmitter
		Flash Green	Disconnected with the transmitter
		Solid Red	Ambient mode

Setting Up the HT380

Powering up the transmitter/charging dock

Connect it to a compatible power source using the AC/DC adapter. Indicator ③ lights up **GREEN**.

Note: If no audio signal detected within 5 minutes after power on, indicator ③ **will turn off**.

Turning on the neck-loop receiver

Slide ⑫ ON/OFF switch to "ON" position, indicator ⑮ on the neck-loop receiver flashes **GREEN**.
When successfully connected to the transmitter, ⑮ will turn **SOLID GREEN**.

Plug the wired earphone

Plug the wired earphone to the ⑲ port on the neck-loop receiver.
Please ensure that the wired earphone is **FULLY** and **FIRMIY** plugged in.

Connecting the Transmitter to Your TV/Audio Source

Now that you've completed step 1, ⑮ on the neck-loop receiver should be **SOLID GREEN**, indicating that the transmitter has successfully connected to the receiver and is ready for use.

After you've connected the HT380 to your TV/audio while following the steps shown in the sections below, if you still can't hear anything through the earphones, please either adjust the TV audio output settings as suggested or contact your TV manufacturer for support.

Check Your TV/Audio Source Output Options

	Optical OUT	AUX/3.5mm	RCA jacks labeled "AUDIO OUT"	Receiver Phone Jack	Output ports not available/hard to reach	Other RCA jacks (usually audio IN)
Jack Options						
Natively Supported?	✓	✓	✓	✓	✓	✗

Fig 2-1 Output options

TVs with Digital Optical/Spdif Audio Out

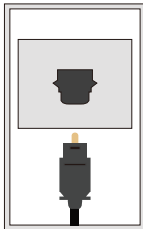
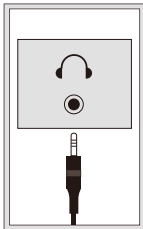
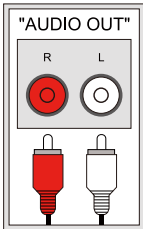
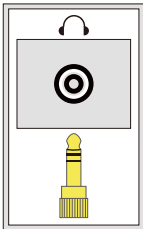
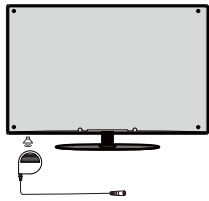
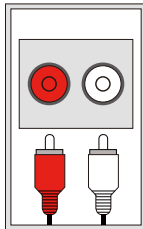
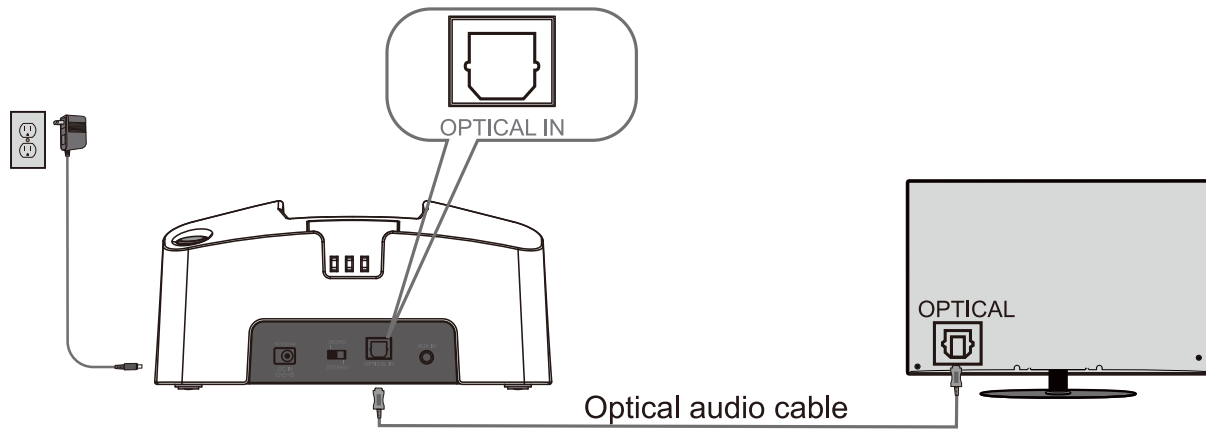

Fig 2-2 Set up the transmitter using optical audio out

After connecting cables, adjust your TV setting as following:

- 1) Ensure your TV Speaker is set to "External Speaker."
- 2) Ensure that your TV Digital Audio Out is set to "PCM" or "Dolby/DTS" is set to OFF(not Auto).

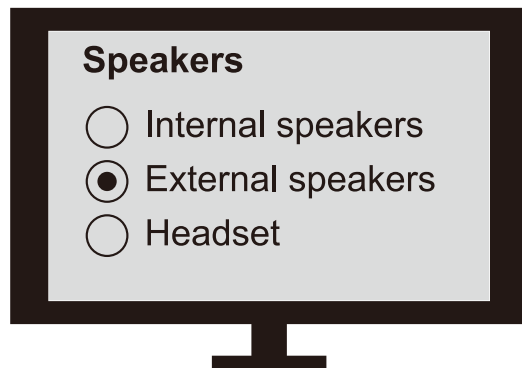

Fig 2-3 Set TV speaker to "External Speaker"

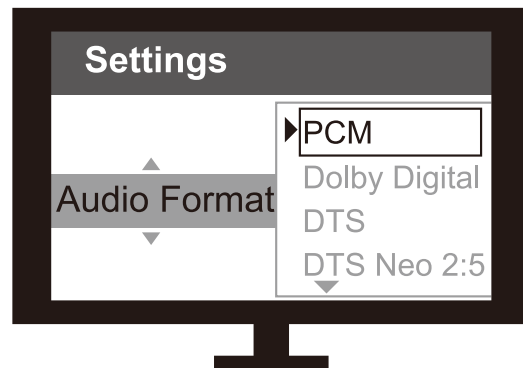

Fig 2-4 Set TV Audio Format to "PCM"

Note:

Unplug any devices from the AUX 3.5mm jack while using the OPTICAL audio out. (If anything is plugged into the AUX jack, the transmitter will preferentially default to the AUX signal and ignore any OPTICAL input.)

TVs with AUX 3.5mm Audio Out

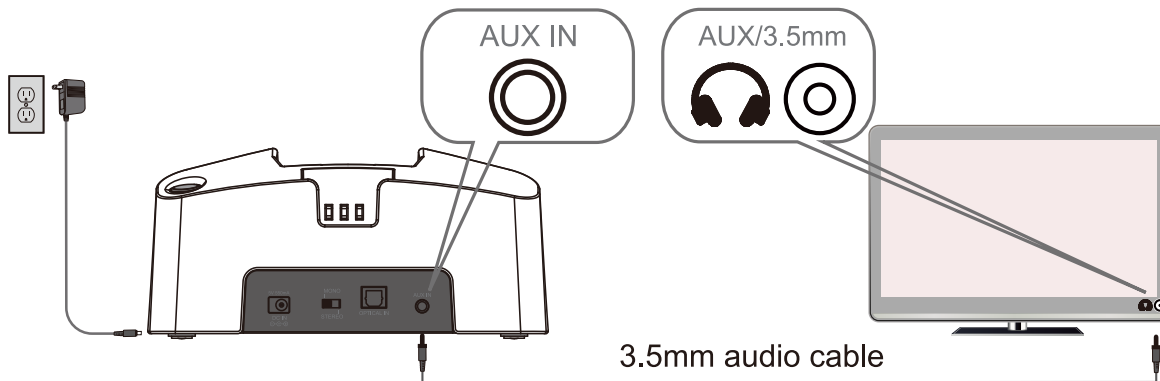

Fig 2-5 Set up the transmitter using AUX 3.5mm audio out

After connecting, you should be able to hear your device through the headphones; if not:

- 1) Ensure your TV speaker setting is set to "Headset".

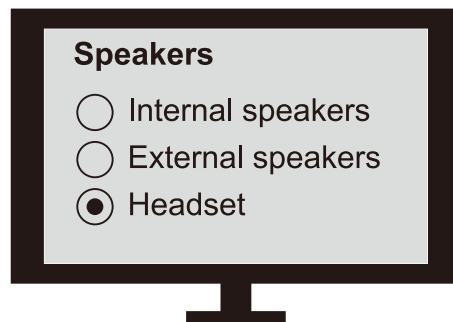

Fig 2-6 Set TV speaker to "Headset"

- 2) Plug wired headphones into the headphone jack on TV; see if you can hear anything.

TVs with RCA Audio Out (Red/White Ports Labeled "AUDIO OUT")

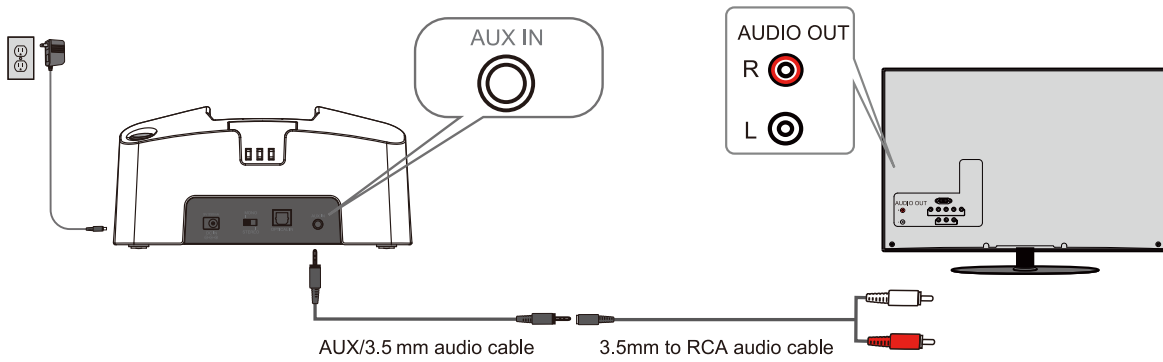

Fig 2-7 Set up the transmitter using RCA audio out

After connecting, you should be able to hear your device through the headphones; if not:

- 1) Ensure using TV Red/White ports labeled **"AUDIO OUT"**; other Red/White ports will NOT work.
- 2) Ensure your TV Speaker setting is set to "External Speaker".
- 3) Plug wired headphones into RCA ports with AUX 3.5mm to RCA audio adaptor cable to see if you can hear anything.

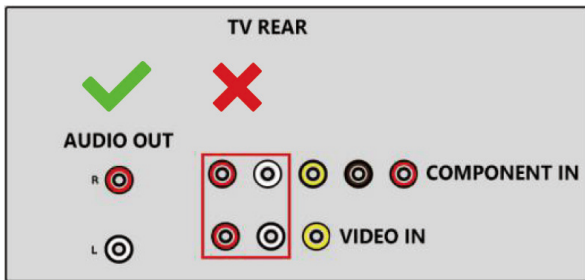

Fig 2-8 Use the correct RCA ports

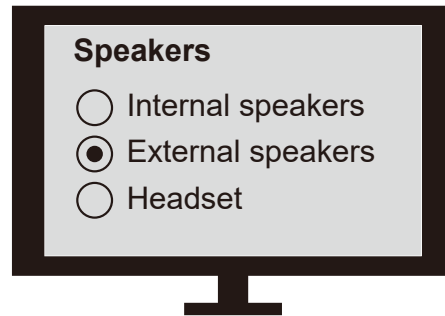

Fig 2-9 Set TV speaker to "External Speaker"

Receiver with 6.35mm Phone Jack at Front

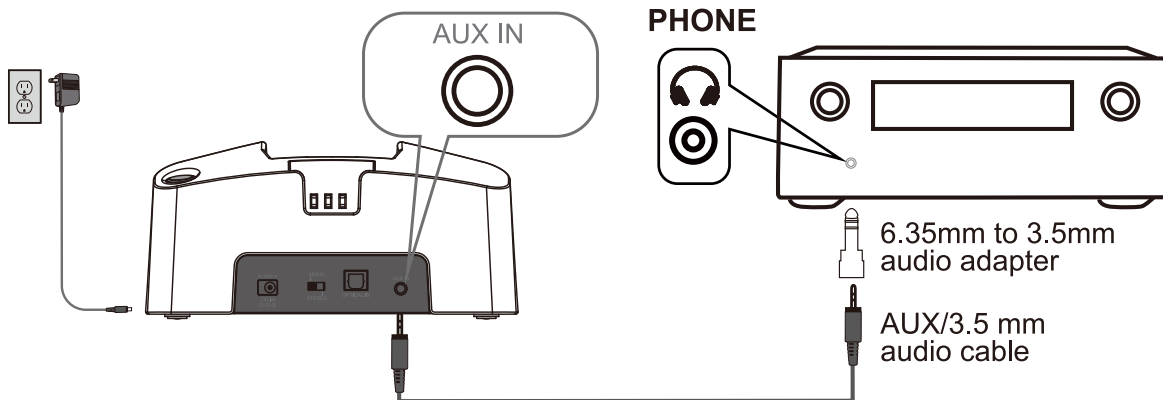

Fig 2-10 Set up the transmitter using 6.35mm phone jack

After connecting, you should be able to hear your device through the headphones;

If not:

Plug any wired headphone into the converter plug, adjust the volume on the AV Receiver to a suitable level. Try it on to see if you can hear anything through the headphones. Please ensure that the volume is set to a comfortable listening level to avoid damaging your hearing.

If You Cannot Reach/Do Not Have Output Ports On Your TV

If no “audio out” port is available on your TV or if the ports are hard to reach, you may also use the TV’s built-in speaker. Simply using the sticker to stick the external microphone (both the sticker and external microphone coming with the HT280) to your TV (near your TV speaker). It should pick up the audio and transmit the audio to the earphones.

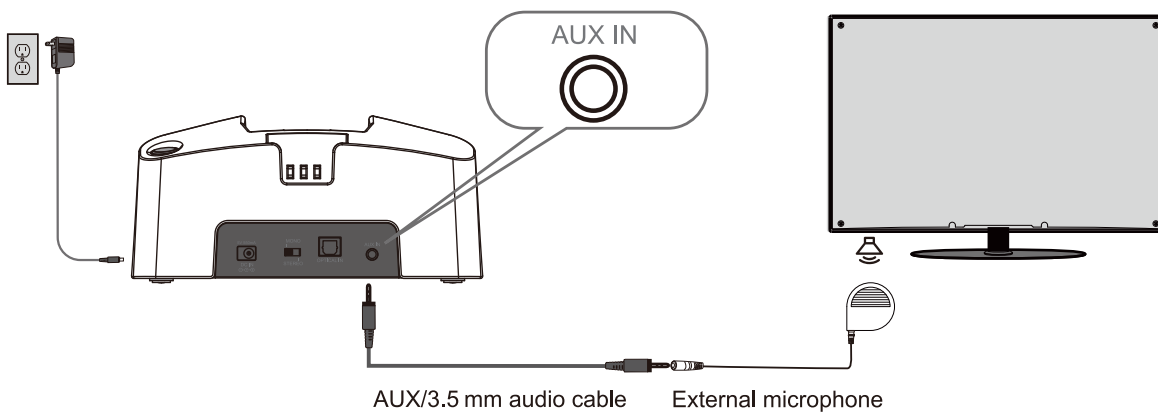

Fig 2-11 Set up the transmitter using TV's built-in speaker

Notes:

Please note that the sound quality produced by this method may not be as good as that of optical/analog connections.

Usually the TV's built-in speaker locates at the bottom of the TV. However, it may vary depending on the TV's brand & model. Please refer to your TV's user manual for more details.

Before sticking the external microphone to your TV, we recommend trying a few different spots to find the optimum position for the best sound quality.

Ambient Function

To have the device pick up sounds in the surrounding, press the AMBIENT button ONCE. You'll see the power indicator (15) on the neck-loop receiver turn RED and hear TWO beeps from the earphone. Please note that the audio from the audio source such as your TV will be cut off under this mode.

To turn off this ambient function, press the AMBIENT button ONCE. The power indicator ⑮ will turn GREEN, and you'll start getting audio from the audio source such as your TV again.

Left-right Audio Balance Control

Via the audio balance controls on the back of the neck-loop receiver, you can adjust the volume of each earbud and customize it to fit your hearing levels.

Mode Selection

HT380 offers 4 different modes that you may choose from: Flat (default setting, no LED indicator), Balanced, Treble, and Bass. Press the MODE button ⑯ ONCE to switch between modes. The LED indicator ⑰ will light up accordingly.

Charging

When the battery is low, you'll start hearing THREE "beeps" every minute from the earphones. The neck-loop receiver will automatically turn off within about 5 minutes.

Now, you can:

Option 1 –Swap in the spare battery

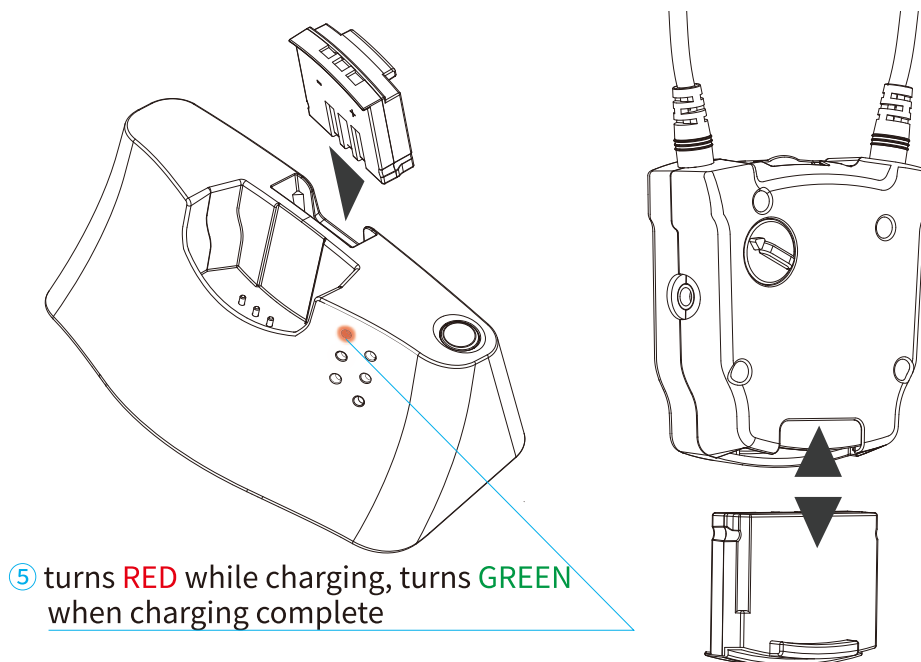

Charge the spare battery

Install battery

Option 2 - Charge the neck-loop receiver

Turn off the neck-loop receiver and place it into the charging cradle on the transmitter, LED indicator ④ lights up **RED** while charging.
When the charging is complete, ④ turns **GREEN**.

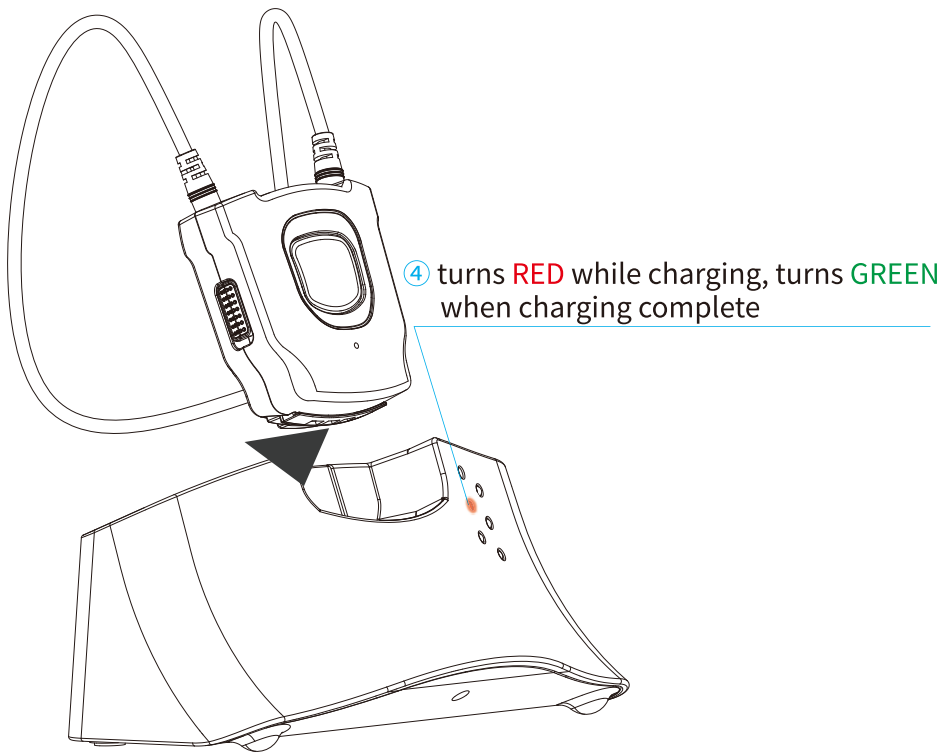

Any questions? Please visit:

support.avantree.com
(User Manuals, FAQ, Video Tutorials and more)

Email support: support@avantree.com (Response Time: 1 working day)
Live chat: www.avantree.com

WARNINGS / CAUTIONS

- Permanent hearing loss may result from long-term exposure to sound at high volumes.
- This product contains small parts which may be a choking hazard. Not suitable for children under age 3.
- To reduce the risk of fire or electrical shock, do NOT expose this product to rain, liquids or moisture.
- Do NOT make unauthorized alterations to this product.
- Do NOT expose products containing batteries to excessive heat (e.g. direct sunlight, fire, etc.).
- Do NOT leave a fully charged battery connected to a charger; overcharging may shorten its life.

Declaration of Conformity

CE: The product is in conformity with the essential requirements of Article 3.1 (a) (b), 3.2 of Directive 1999/5/EC and the essential requirements of Directive 2004/108/EC. This device complies with part 15 of the FCC Rules. Operation is subject to the condition that this device does not cause harmful interference (1) this device may not cause harmful interference, and (2) this device must accept any interference received, including interference that may cause undesired operation. Changes or modifications not expressly approved by the party responsible for compliance could void the user's authority to operate the equipment.

NOTE: This equipment has been tested and found to comply with the limits for a Class B digital device, pursuant to Part 15 of the FCC Rules. These limits are designed to provide reasonable protection against harmful interference in a residential installation. This equipment generates, uses and can radiate radio frequency energy and, if not installed and used in accordance with the instructions, may and used in accordance with the instructions, may cause harmful interference to radio communications. However, there is no guarantee that interference will not occur in a particular installation. If this equipment does cause harmful interference to radio or television reception, which can be determined by turning the equipment off and on, the user is encouraged to try to correct the interference by one or more of the following measures:

- Reorient or relocate the receiving antenna.
- Increase the separation between the equipment and receiver.
- Connect the equipment into an outlet on a circuit different from that to which the receiver is connected.
- Consult the dealer or an experienced radio/TV technician for help.

FCC ID: 2AITF-WSHT-380

To maintain compliance with FCC's RF Exposure guidelines, this equipment should be installed and operated with minimum distance between 20cm the radiator your body: Use only the supplied antenna.

Dispose of the packaging and this product in accordance with the latest provisions.



Z-PKQG-HT380-V0