



HF2039

Extra Long Wired Headphones for TV

Model No: TVHF-2039

Quick Start Guide
Schnellanleitung
Guide de démarrage rapide
Guida Rapida all'uso
Guía de iniciación rápida

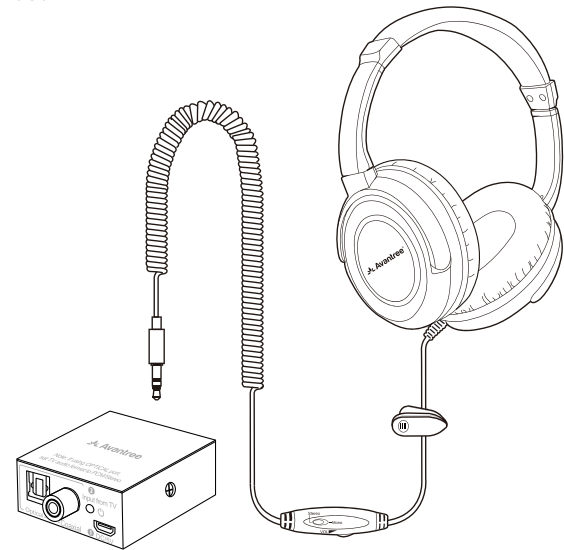

IMPORTANT NOTICE



*Please watch **step-by-step video tutorial** from avantree.com/2039/video before installation.



Box Contents



Wired Headphone - HF039



Digital to Analog Audio Converter (DAC)



3M Sticker

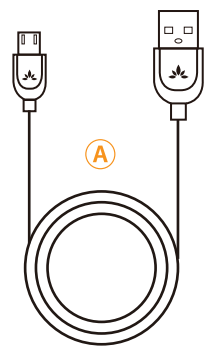

Micro USB Power Cable

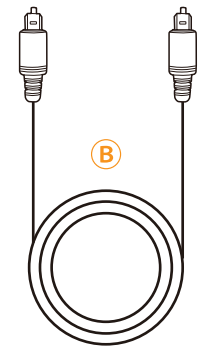

Optical Audio Cable

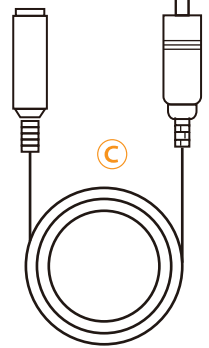

2M Extension Cable

1 Power up the DAC

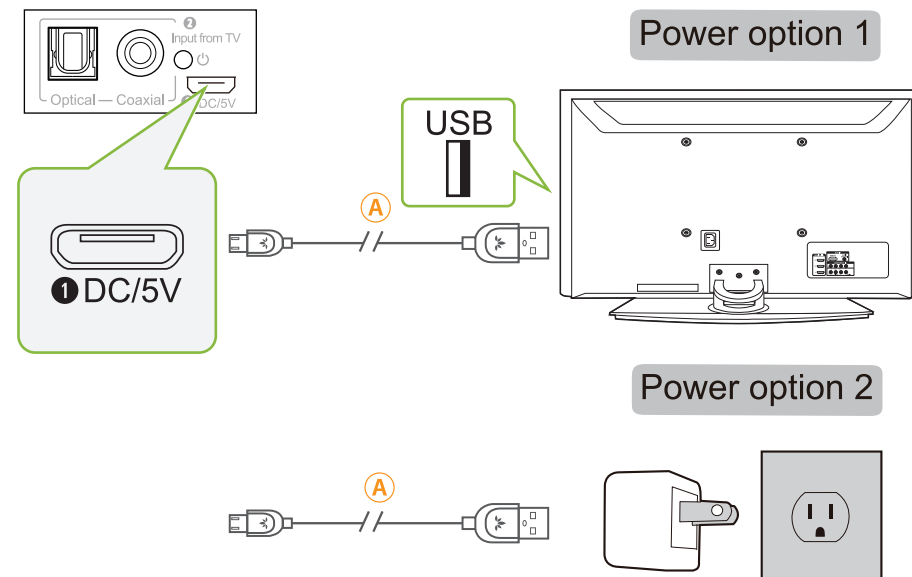

Contact us at support@avantree.com for a FREE USB wall charger (for US / UK / EU) if you need one.

DE: Kontaktieren Sie uns unter support@avantree.com für ein KOSTENLOSES USB-Wandladegerät (für US / UK / EU), wenn Sie eines benötigen.
FR: Contactez-nous à support@avantree.com pour un chargeur mural USB GRATUIT (pour les États-Unis / Royaume-Uni / UE) si vous en avez besoin.
IT: Contattaci all'indirizzo support@avantree.com per un caricatore da muro USB GRATUITO (per USA/Regno Unito/UE) se ne hai bisogno.
ES: Póngase en contacto con nosotros en support@avantree.com para obtener un cargador de pared USB GRATIS (para EE. UU./RU/UE) si lo necesita.

2 Connecting the DAC to your TV

If using OPTICAL port:

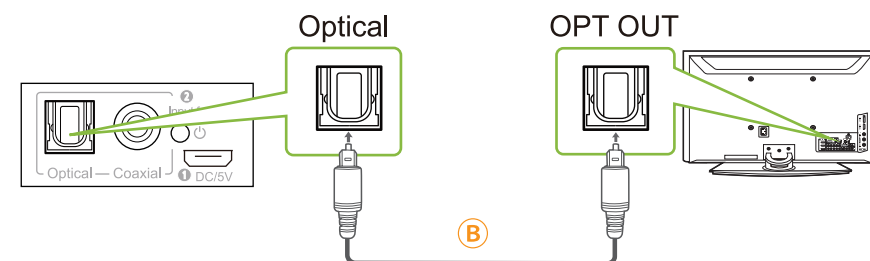

If using COAXIAL port:

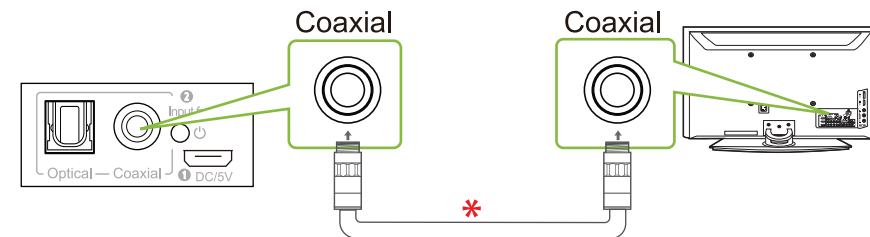

*Coaxial cable not included; please purchase one separately if needed.

DE: Koaxial-Audiokabel ist nicht im Lieferumfang enthalten; Sie müssen es separat erwerben.
FR: Le câble audio coaxial n'est pas inclus dans l'emballage; vous devez l'acheter séparément.
IT: Il cavo audio coassiale non è incluso nella confezione; è necessario acquistarlo separatamente.
ES: El cable de audio coaxial no está incluido en el paquete; necesita comprarlo por separado.

3 TV sound setting - OPTICAL ONLY



4 Plug the HF039 into the DAC

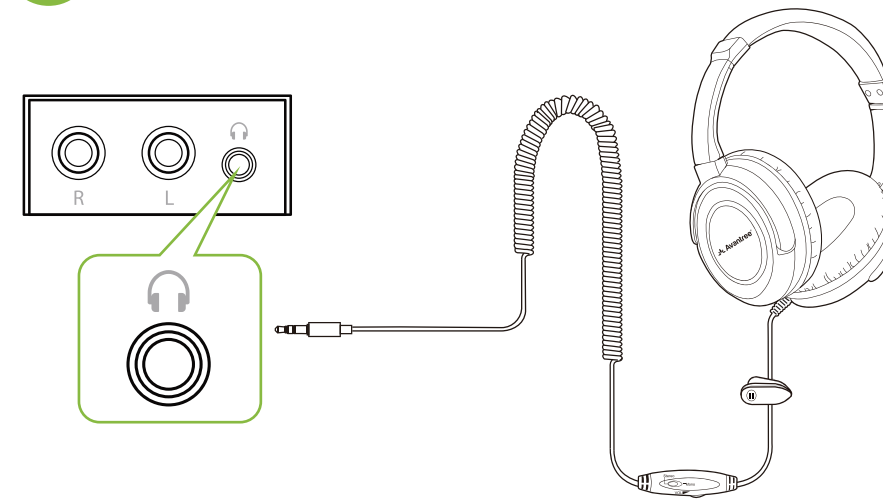

? Online Support

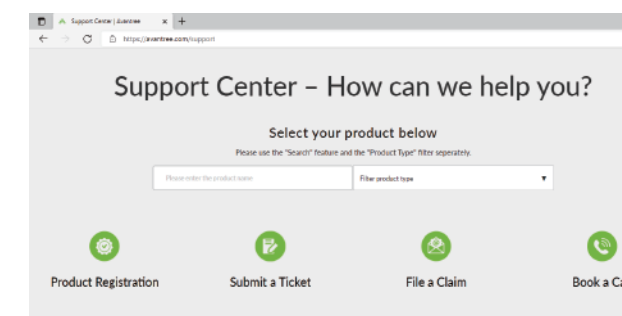

Troubleshooting & FAQ

1. Wired headphone is still not enough long?
2. DAC cannot be fixed on the table?
.....More FAQ and User tips are available online.

DE:

1. Kabelgebundener Kopfhörer ist immer noch nicht lang genug?
2. DAC lässt sich nicht auf dem Tisch fixieren?
.....Mehr FAQ und Benutzertipps sind online verfügbar.

FR:

1. Le casque filaire n'est toujours pas assez long ?
2. Le DAC ne peut pas être fixé sur la table ?
.....Plus de FAQ et de conseils d'utilisation sont disponibles en ligne.

IT:

1. Le cuffie cablate non sono ancora abbastanza lunghe?
2. Il DAC non può essere riparato sul tavolo?
.....Altre domande frequenti e suggerimenti per gli utenti sono disponibili online.

ES:

1. ¿Los auriculares con cable todavía no son lo suficientemente largos?
2. ¿El DAC no se puede fijar en la mesa?
.....Más preguntas frecuentes y consejos para el usuario están disponibles en línea.



Accessories & Add-Ons

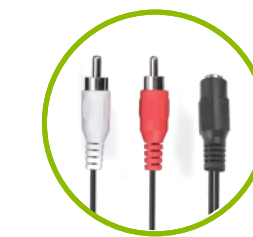

AUX 3.5mm to RCA Adapter



3.5mm Extension Cable



Micro USB power Cable



Contact Us

	avantree.com/submit-a-ticket
	support@avantree.com
	<p>USA / Canada: +1800 232 2078 (US Toll Free, 9am-6pm PST, Mon-Fri)</p> <p>UK: +44 20 8068 2023 (9am-6pm, GMT, Mon-Sat)</p> <p>DE: +49 32221097297 (11am-9pm, CET, Mon-Sat)</p> <p>FR: +33 176340312 (11am-9pm, CET, Mon-Sat)</p> <p>IT: +39 06 9480 3330 (9am-6pm, CET, Mon-Sat)</p> <p>ES: +34 931786261 (9am-6pm, CET, Mon-Sat)</p> <p>AU: +61 2 8310 9897 (11am-7pm, Sydney Time, Mon-Fri)</p>



Register for your extended 24 Months warranty at avantree.com/product-registration



Z-PKQG-HF2039-V0