

编号: Z-PKQG-4189-B-V0  
 材质: 80g书纸+四色印刷+正反印刷  
 尺寸: 420mmX320mm 折后: 140mmX160mm

# HT4189B

Quick Start Guide | Schnellanleitung | Guide de démarrage rapide  
 Guida Rapida all'uso | Guía de inicio rápido | クイックスタートガイド



**Avantree**

Model No.: BTHHT-4189-B

## Box Contents

Inhalt | Contenu de la boîte | Contenuto della confezione | Contenido | 箱の中身

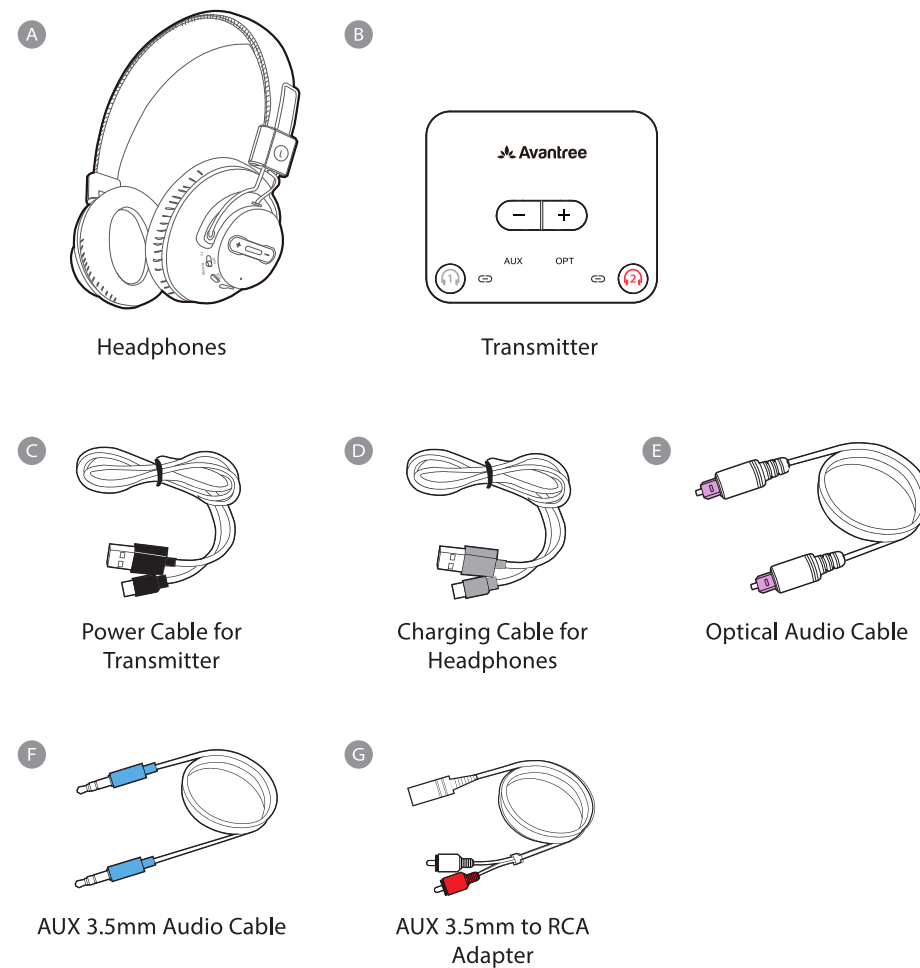

## Accessories

Optionales Zubehör | Accessoires optionnels | Accessori opzionali |  
 Accesorios opcionales | アクセサリー



**HT4189B Headphones**  
 Extra pair of headphones for HT4189B



**USB-C Cable**  
 USB-C charge cable



**Ear Pads**  
 Replaceable ear pads

Visit [avantree.com](http://avantree.com) for accessories

## Contact Us

Kontaktieren Sie uns | Contactez-nous | Contattaci | Contáctenos | お問い合わせ

**Support Tickets** [avantree.com/submit-a-ticket](http://avantree.com/submit-a-ticket)

**Support Email** [support@avantree.com](mailto:support@avantree.com)

**US/CA** +1 800 232 2078 (9am-6pm, PST, Mon-Fri)  
**UK** +44 20 8068 2023 (9am-6pm, GMT, Mon-Sat)  
**DE** +49 32221097297 (11am-9pm, CET, Mon-Sat)  
**FR** +33 176340312 (11am-9pm, CET, Mon-Sat)  
**IT** +39 06 9480 3330 (9am-6pm, CET, Mon-Sat)  
**ES** +34 931786261 (9am-6pm, CET, Mon-Sat)  
**AU** +61 2 8310 9897 (11am-7pm, AEST, Mon-Fri)

**FAQ** [avantree.com/support/4189b](http://avantree.com/support/4189b)

**Product Registration** [avantree.com/product-registration](http://avantree.com/product-registration)



Model No: BTHHT-4189-B  
 Dispose of the packaging and this product in accordance with the latest provisions.  
 Z-PKQG-4189-B-V0

## Product Overview

Produktübersicht | Vue d'ensemble du produit | Panoramica Prodotto |  
 Descripción general del producto | 製品概要

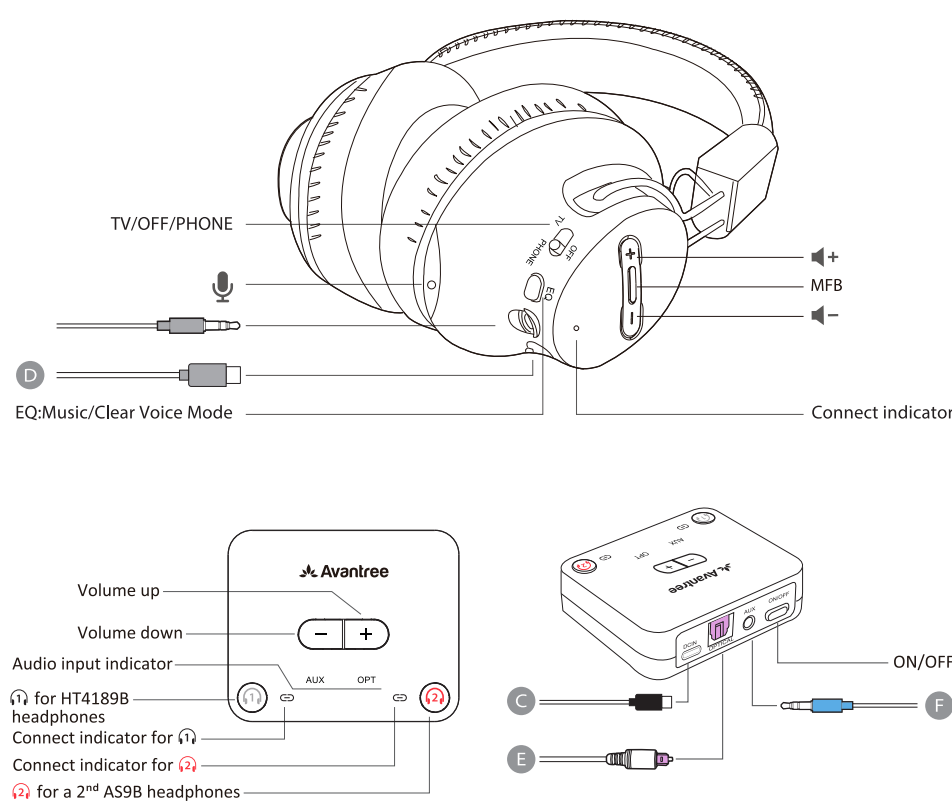

## Charging

Aufladen | Mise en charge | Carica | Cargando | 充電

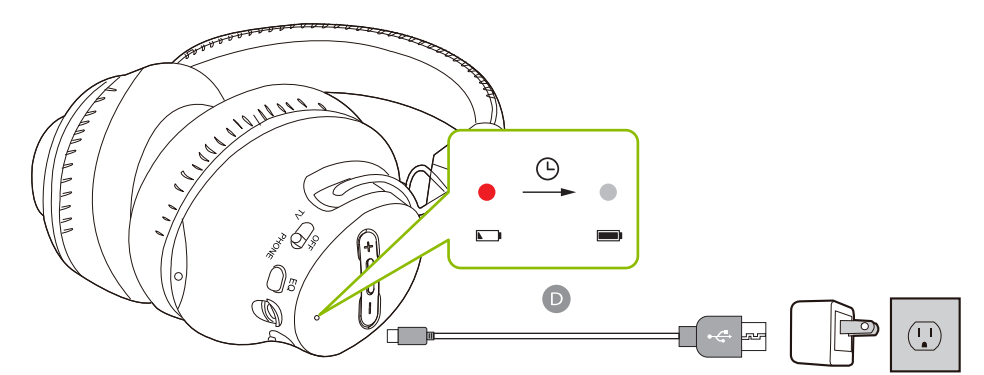

## 1 TV Connection

TV-Anschluss | Connexion au téléviseur | Collegamento TV |  
 Conexión de televisión | テレビの接続

**OPTION A**  
**For TVs with OPTICAL port**

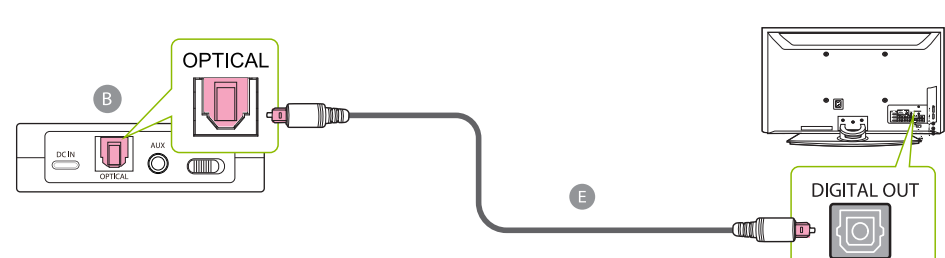

**OPTION B**  
**For TVs with AUX 3.5MM port**

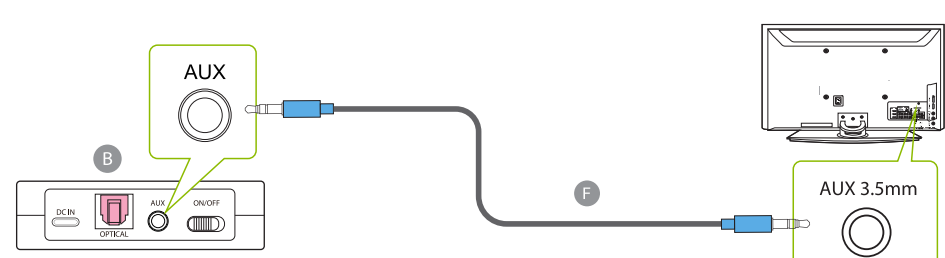

**OPTION C**  
**For TVs with RCA AUDIO OUT port**

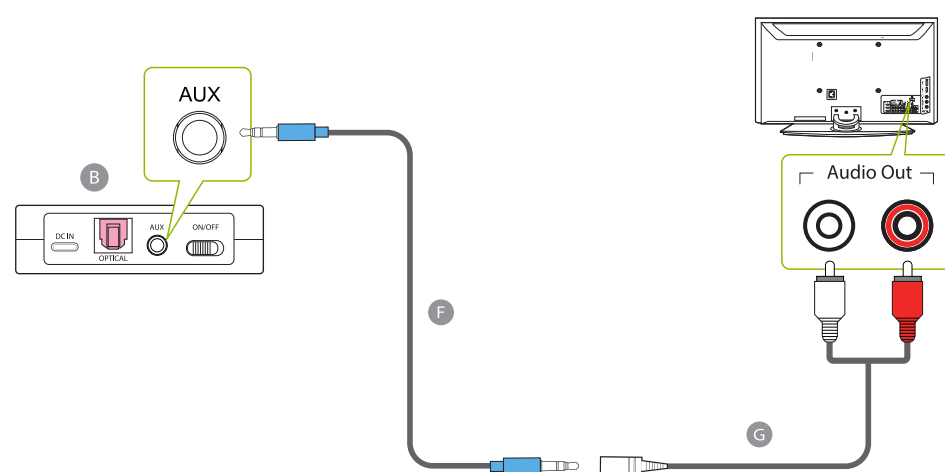

**Still need help?**  
 Visit [avantree.com/4189b/connect-to-tv](http://avantree.com/4189b/connect-to-tv) for more details

## 2 Headphones Connection

Kopfhöreranschluss | Connexion casque | Collegamento cuffie |  
 Conexión de auriculares | ヘッドホンの接続

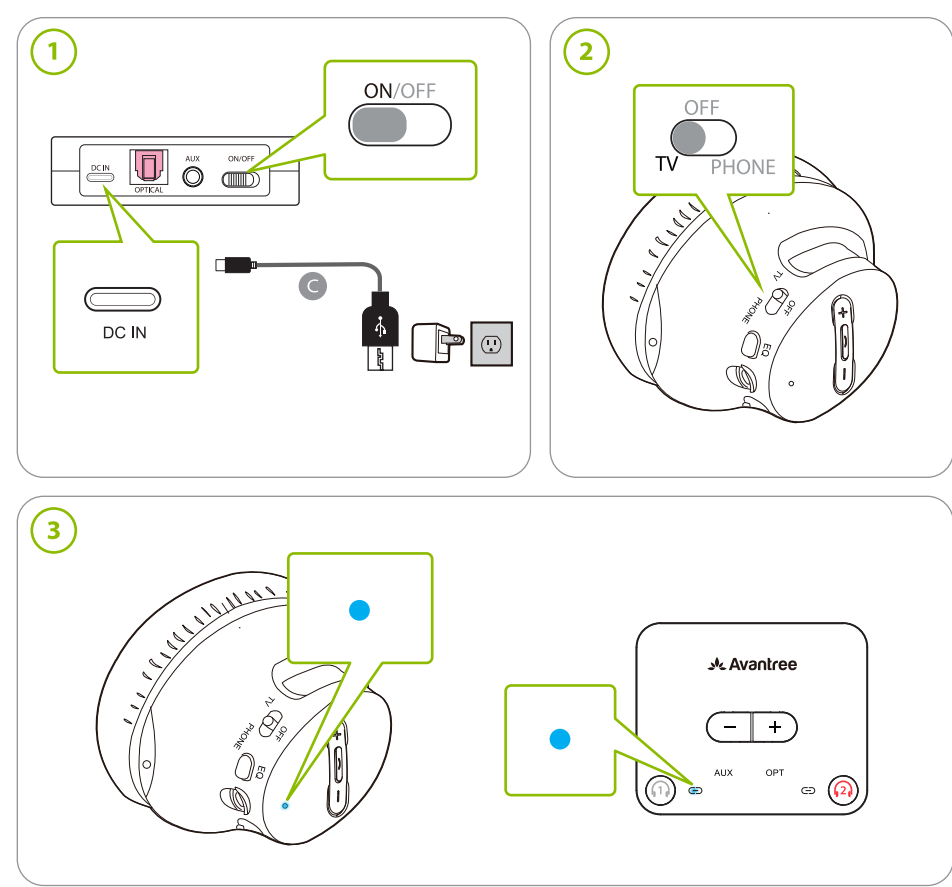

**Still need help?**  
 Visit [avantree.com/4189b/headphones-connection](http://avantree.com/4189b/headphones-connection) for more details

## 3 TV Set Up

Fernseher eingerichtet | Connexion au téléviseur | Impianto televisivo |  
 Configuración de televisión | テレビのセットアップ

**For using TV Optical / Toslink / SPDIF port**

**1** **REMOTE CONTROL**  
 Go to SETTINGS > Audio > Optical / Digital Out

**2** **REMOTE CONTROL**  
 Digital Audio Format > PCM / Stereo OR Dolby - Off

## Audio Setting Guide



**Still need help?** Visit [avantree.com/4189b/tv-audio-settings](http://avantree.com/4189b/tv-audio-settings) for more details.

## 4 Using the Headphones with Your Phone

Verwenden der Kopfhörer mit Ihrem Telefon | Utilisation du casque avec  
 votre telephone | Utilizzo delle cuffie con il telefono | Uso de los auriculares con  
 su teléfono | 電話機でヘッドフォンを使用する

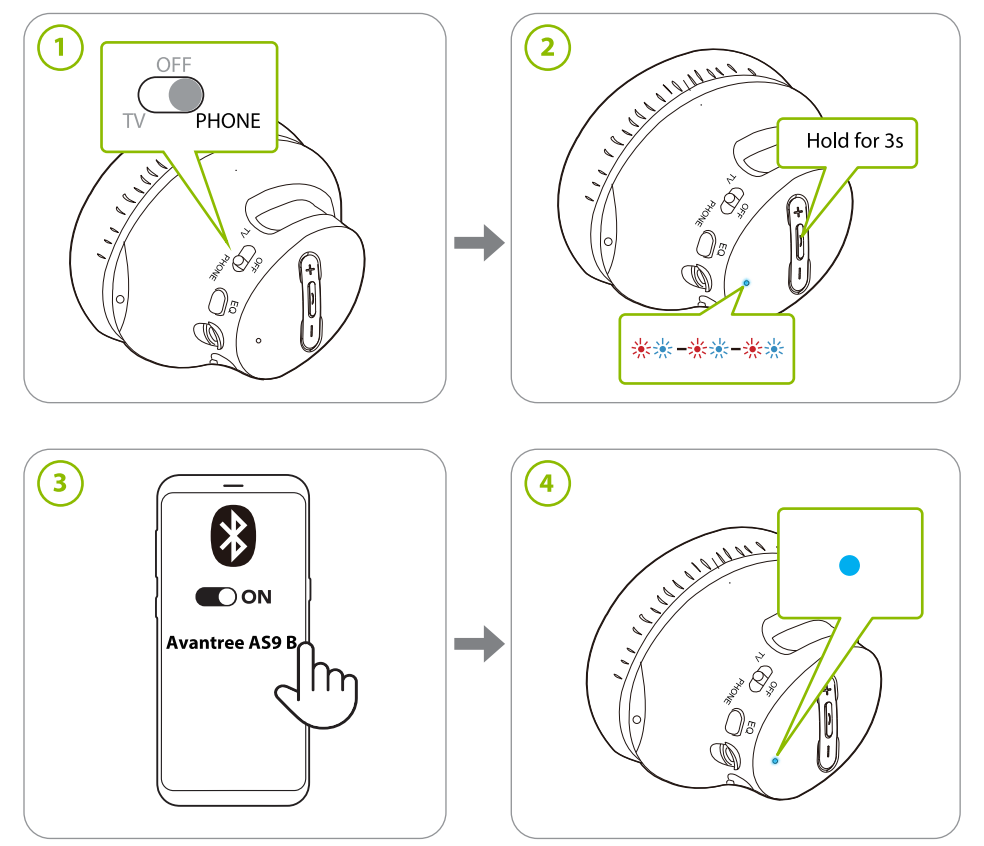

## Online Support

Soporte en línea | Support en ligne | Supporto Online | Soporte en línea |  
 オンラインサポート

## Troubleshooting & Advanced Functions

**EN** 1. Avantree TV Headphones Troubleshooting for no sound / not working  
 2. Netflix / Amazon Prime No Sound in the Headphones

**DE** 1. Avantree TV-Kopfhörer Fehlerbehebung für keinen Ton / funktioniert nicht  
 2. Netflix / Amazon Prime Kein Ton in den Kopfhörern

**FR** 1. Dépannage des écouteurs TV Avantree pour aucun son / ne fonctionne pas  
 2. Netflix / Amazon Prime Pas de son dans les écouteurs

**IT** 1. Risoluzione dei problemi delle cuffie TV Avantree per assenza di suono/non funzionanti  
 2. Netflix / Amazon Prime Nessun suono nelle cuffie

**ES** 1. Solución de problemas de los auriculares Avantree TV sin sonido/no funciona  
 2. Netflix/Amazon Prime Sin sonido en los auriculares

**JP** 1. Avantree TVヘッドフォンの音が出ない/動作しない場合のトラブルシューティング  
 2. Netflix / Amazon Prime ヘッドフォンから音が出ない

Visit [avantree.com/support](http://avantree.com/support)

